



Features

- Fanless system with IBASE MB220 customized board
- Supports 7th/6th Gen Intel® Core™ i7/i5/i3 processors (35W TDP)
- Operating temperature ranging from -10°C to 50°C
- Dual SIM slot support WWAN redundancy
- 12V to 24V DC wide-range voltage input
- Over/Under/Reverse voltage protection
- iSMART, iAMT (11.6), (TPM 2.0)

Specifications

System Mainboard	MB220AF with Intel® Q170 PCH MB220EF with Intel® H110 PCH
CPU Type	7th/6th Gen Intel® Core™ i7/i5/i3 desktop processors (35W TDP)
System Speed	Up to 3.4GHz
Memory	2x 2GB DDR4 SO-DIMM Slots, Max. 32GB, 2400MHz
Construction	Aluminum & steel
Chassis Color	Silver & Gray (Aluminum)
Front Panel External I/O	1x DVI-D + 1x VGA 1x Audio jack for MIC-in / Line-out 4x USB 2.0 ports 1x Red HDD LED 1x Power button with green LED indicator 1x CFast socket, 2x SIM card slots 1x 2-pin terminal block for external power button 1x Front removable drive bay for SSD
Rear Panel External I/O	1x RS232/RS422/485 port for COM#1 5x RS232 port for COM#2/COM#2~6 2x DisplayPort connector 1x RJ45 Gigabit Ethernet port + 2x USB 3.0 port 1x RJ45 Gigabit Ethernet port + 2x USB 3.0 port 1x 3-pin DC-in terminal block type for 12V~24V 2x USB 2.0 port 2x Antenna holes 2x Expansion slots
Expansion slots	2x Mini PCI-E sockets + 1x CFast slot
Storage	2x 2.5 SSD (1x internal & 1x external-accessible) 2x mSATA (AMI222AF only) & 1x mSATA (AMI222EF only) RAID 0,1,5,10 supported (AF version only)
Mounting	Desktop or wall mount (wall mount kit included)
Dimensions	210mm (W) x 265mm (D) x 128.6mm (H)
Weight	4.3kg
Operating Temperature	-10°C to 50°C (14°F~122°F)
Storage Temperature	-20°C ~ 80°C (-4°F~176°F)
Relative Humidity	5~90% @ 45°C, (non-condensing)
Vibration	Non-Operating: 1.0 grms / 5~500Hz / random operation Operating: 0.25 grms / 5~500Hz / random operation
Shock	Operating : 20G/ 11ms ; Non-Operating : 40G/ 11ms (MIL-STD-810G)
Certification	CE / LVD / FCC Class B

Ordering Information

AMI222AF	Fanless box System with MB220AF, w/ Intel® Core™ i7/i5/i3 desktop processor, 6x COM, 2x 4GB memory, 1x 2.5" 64GB MLC industrial-grade SSD, w/o power adaptor, optional riser card
AMI222EF	Fanless box System with MB220EF, w/ Intel® Core™ i7/i5/i3 desktop processor, 6x COM, 2x 4GB memory, 1x 2.5" 64GB MLC industrial-grade SSD, w/o power adaptor, optional riser card
150W power adaptor (Optional)	150W (12V@12.5A) power adaptor, bare wire type

Recommended Processor list

Model	TDP	Base Freq	Turbo Freq	Cache	Cores / Threads
i7-7700T	35W	2.9 GHz	3.8 GHz	8M	4/8
i7-6700TE	35W	2.4 GHz	3.4 GHz	8M	4/8
i5-7500T	35W	2.7 GHz	3.3 GHz	6M	4/4
i5-6500TE	35W	2.3 GHz	3.3 GHz	6M	4/4
i3-7101TE	35W	3.4 GHz	N/A	3M	2/4
i3-6100TE	35W	2.7 GHz	N/A	4M	2/4
G4400TE	35W	2.9 GHz	N/A	3M	2/2
G3900TE	35W	2.6 GHz	N/A	2M	2/2

Expansion Cards

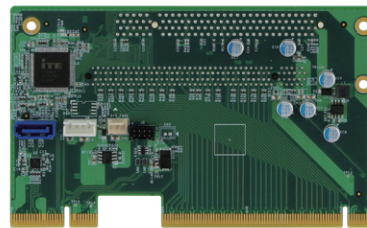
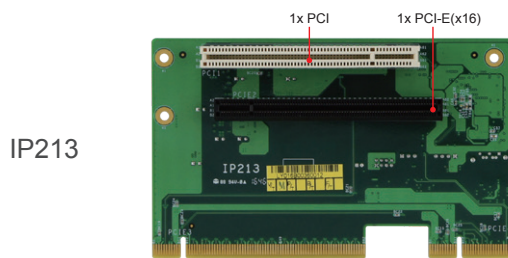
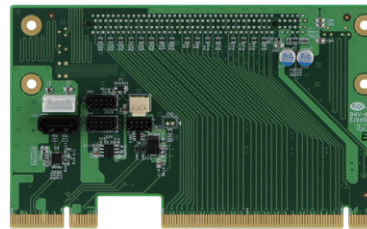
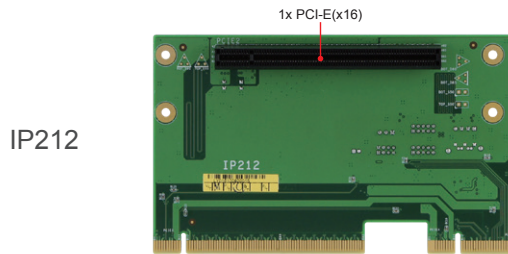
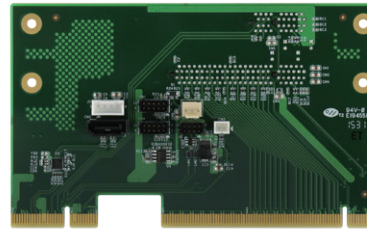
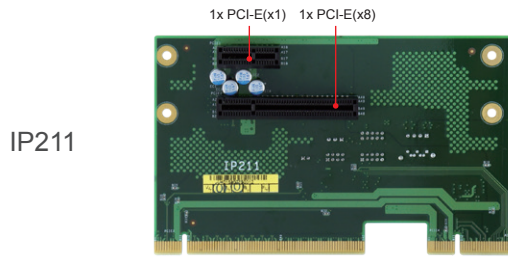

COM#5-6 From IP211/IP212

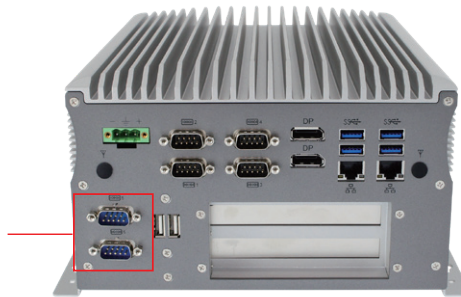

Dimensions and Drawing

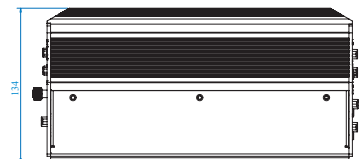
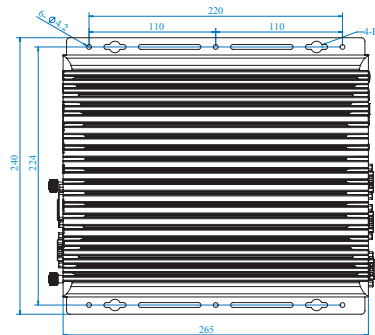
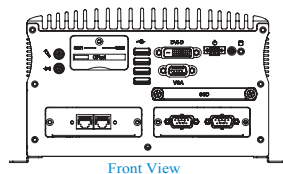
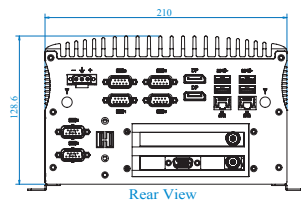

1 Embedded Systems

2 CPU Modules

3 Disk-Size SBCs

4 Motherboards

5 CPU Cards